

# Globaltek® Equipment Bottomless Conveyors

## User's Manual

**WARNING:** Read this User's Manual in its entirety before setting up or operating the conveyor.

This manual covers the operation and maintenance of the following models of Globaltek's Bottomless Conveyors:

TRA-37S

**Note:** Some of the pictures in this manual are of Globaltek's *TRA-37B* conveyor. The 37S and 37B conveyors are largely the same, with a few small differences in features. Whenever a 37B model is used in a picture, the feature being discussed is identical between the two models.

Video Tutorials	QR Code
<p>Learn all about your new conveyor by watching our on-line video tutorials. Our video tutorials show you everything from unpacking your conveyor, operating your conveyor, and adding accessories to your conveyor.</p> <p><b>Scan the QR code to view the video tutorials.</b></p>	

# Globaltek® Equipment

All rights reserved. No part of this work may be reproduced, copied, adapted, or transmitted in any form or by any means without written permission from Globaltek® Equipment. Globaltek® Equipment makes no representation or warranties with respect to the contents hereof and specifically disclaims any implied warranties of merchantability or fitness for any particular purpose. Further, Globaltek® Equipment reserves the right to revise this publication and to make changes from time to time in the content hereof without obligation to notify any person of such revision or changes. ©2023 Globaltek® Equipment.



**CAUTION:** Read this manual in its entirety before attempting to set up or operate the conveyor. Failure to do so could cause bodily harm and/or damage to the conveyor.

While reading this User's Manual, you will sometimes see call out boxes or headings with the term Note, Caution, Warning, and Danger.

**Notes, Cautions, Warnings, and Dangers** notify the reader that incorrectly following instructions could damage the conveyor or could cause bodily injury.

## **Preface:**

This manual introduces you to the Globaltek® Equipment's Bottomless Conveyors. The manual will orient you to the many features and procedures that enable you to set up and operate the bottomless conveyors.



**CAUTION:** If the conveyor is used in a manner not specified by the manufacturer, the protection provided by the equipment may be impaired.

## **Globaltek® Equipment on the Internet**

For further information on documentation and support for your conveyor or for information on other Globaltek® Equipment products, please visit our web site:

<https://www.globaltekequipment.com/>.

## Table of Contents

Preface .....	2
Table of Contents .....	3
About Globaltek® Equipment.....	4
Safety Information	
Safety Symbols .....	4
Globaltek® Equipment Safety Labels .....	5
Electrical Safety .....	7
Operational Safety.....	8
Lockout/Tagout Procedures .....	10
Lifting Points of the Bottomless Conveyor .....	10
Specifications .....	11
Electrical Requirements .....	11
Parts of the Bottomless Conveyor .....	12
The Motor Controller .....	12
The Start and Stop Buttons.....	13
The Speed Control .....	14
The Current Speed Indicator .....	14
The AC Power Cord.....	14
Connecting the Power Cord to an Electrical Outlet .....	14
Grounding Instructions.....	15
The Motors .....	15
Height Adjustable Feet .....	16
Raising and Lowering the Conveyor .....	16
Levelling the Conveyor .....	17
The Belts .....	19
Adjusting the Width of the Belts .....	19
Adjusting the Height of the Belts .....	20
Adjusting the Tension of the Belts .....	22
Replacing the Belts.....	24
Unpacking the Bottomless Conveyor .....	28
Operating Instructions (Getting Started) .....	30
Installing a Printer on your Bottomless Conveyor.....	32
Troubleshooting.....	39
Maintenance Guidelines.....	40
Contact Technical Support.....	41
Warranty.....	41

## About Globaltek® Equipment

Established in 2006, Globaltek® Equipment is a family owned and operated business. Our cutting-edge manufacturing facility and headquarters are located in Miami, Florida. We manufacture packaging conveying systems comprising inline conveyors, transporting and transfer systems, and accumulating tables.

All of our packaging systems are constructed of UL Certified and Made in the USA components. Our conveyors feature 304 stainless steel construction, as well as a made in USA Bodine motor with variable speed controller.

### Safety Information:

#### Safety Symbols:

The purpose of safety symbols is to attract your attention to possible dangers. The safety symbols, and the explanations with them, deserve your careful attention and understanding. The symbols do not by themselves eliminate any danger. The instructions and warnings they give are not substitutes for proper accident prevention measures.

**DANGER:**

Failure to obey this safety warning **WILL** result in death or serious injury to yourself or others.

**WARNING:**

Failure to obey this safety warning **CAN** result in death or serious injury to yourself or others.

**CAUTION:**







Failure to obey this safety warning **MAY** result in personal injury to yourself or others or result in damage to the conveyor.



**NOTE:**

Damage to the conveyor may result if these instructions are not followed.

**Globaltek® Equipment Safety Labels:**

The safety label is located on the motor side of the conveyor. It is important to be aware of the meaning of these labels to ensure safe operation of the conveyor.

Description	Label
<p><b>WARNING:</b> Read and understand all of the safety label descriptions in the table below before operating the conveyor.</p> <p><b>Wear Eye/Ear Protection:</b> A reminder that that the conveying process may be harmful to the eyes and ears. Always wear eye protection when operating or when performing maintenance on the conveyor. Proper ear protection is suggested when operating the equipment. Located on the motor side of the conveyor.</p>	 
<p><b>Machine lockout:</b> A reminder to turn off and lock out the electrical supply before servicing any components. Located on the motor side of the conveyor.</p>	
<p><b>General Warning:</b> This area can only be accessed by a trained service technician. Located on the motor side of the conveyor.</p>	
<p><b>Crush Hazard:</b> Keep hands clear while operating. A reminder that various manufacturing processes can present a crush hazard if hands or objects are near the belt of the conveyor. Located on the motor side of the conveyor.</p>	
<p><b>Risk of Electrical Shock:</b> A reminder to unplug the conveyor from the electrical outlet before cleaning or servicing. Located on the motor side of the conveyor.</p>	

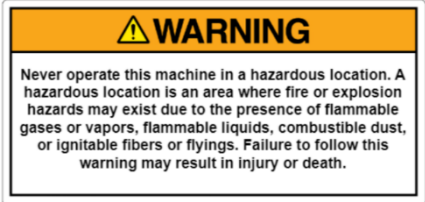
<p><b>Pinch Hazard:</b> Keep hands clear while operating. A reminder that the movement of the conveyor belts can be a pinch hazard if hands or objects are placed in these locations. Located on the motor side of the conveyor.</p>	
<p><b>Shear Hazard:</b> Keep hands clear while operating. A reminder that movement of the conveyor belts can be a shear hazard if hands or objects are placed in this location. Located on the motor side of the conveyor.</p>	
<p><b>Entanglement Hazard:</b> Keep hands clear while operating. A reminder that movement of the conveyor belts could result in entanglement should hands or objects be placed in this location. Located on the motor side of the conveyor.</p>	
<p><b>Risk of Fire or Explosion:</b> A warning to never operate this machine in a hazardous location. A hazardous location is an area where fire or explosion hazards may exist due to the presence of flammable gases or vapors, flammable liquids, combustible dust, or ignitable fibers or flyings. Failure to follow this warning may result in injury or death. Located on the motor side of the conveyor.</p>	 <p><b>WARNING</b></p> <p>Never operate this machine in a hazardous location. A hazardous location is an area where fire or explosion hazards may exist due to the presence of flammable gases or vapors, flammable liquids, combustible dust, or ignitable fibers or flyings. Failure to follow this warning may result in injury or death.</p>

## Electrical Safety

### Hazardous Locations (Explosive Atmospheres):

Never operate this machine in a hazardous location. A hazardous location is an area where fire or explosion hazards may exist due to the presence of flammable gases, vapors, or liquids, or combustible dust, or ignitable fibers or flyings. Failure to follow this warning may result in injury or death.

	<p><b>WARNING:</b> Never operate this machine in a hazardous location. A hazardous location is an area where fire or explosion hazards may exist due to the presence of flammable gases, vapors, or liquids, or combustible dust, or ignitable fibers or flyings. Failure to follow this warning may result in injury or death.</p>
---	---

### Electrical Requirements:

The input voltage to the speed controller on the conveyor is 115 VAC  $\pm$  10%, 50/60 Hz. single phase electricity with a maximum continuous input current of 5.7 amps.

	AC Voltage	Phase	Current
USA	115V	Single Phase Grounded	15A Service 5.7A
Canada	115V	Single Phase Grounded	15A Service 5.7A

### Main Disconnect:

The main disconnect is accomplished by disconnecting the AC power cord at the electrical outlet. Ensure that the power cord and electrical outlet are easily accessible.

	<p><b>WARNING:</b> The main disconnect is accomplished by disconnecting the AC power cord at the electrical outlet. Ensure that the power cord and electrical outlet are easily accessible.</p>
---	---

### Grounding Instructions:

The conveyor must be plugged into a properly installed outlet and grounded in accordance with all codes and ordinances. Never modify the plug in any way. Check with a qualified electrician if you think the outlet may not be properly grounded.

	<p><b>WARNING:</b> The conveyor must be plugged into a properly installed outlet and grounded in accordance with all codes and ordinances. Never modify the plug in any way. Check with a qualified electrician if you think the outlet may not be properly grounded.</p>
---	---

## Operational Safety:



### **DANGER:**

- Do not use the conveyor in the presence of flammable liquids, gases or vapors, combustible dust, or ignitable fibers or filings.
- This product is not designed for, nor intended for use in hazardous areas as defined by ATEX or the NEC (National Electric Code).



### **WARNING:**

- Do not move the conveyor without additional personnel or mechanical assistance.
- Never operate this machine without all safety guards and covers in their proper positions.
- All service must be performed by qualified original manufacturer's service personnel.
- Disconnect and lockout all electrical power and air sources prior to any service or maintenance work.
- Keep hands and foreign objects away from all moving parts and pinch points.
- Keep hands clear of all moving parts, in particular belts, chains, sprockets, and pulleys. Failure to do so could cause injury.
- Always wear OSHA approved eye/ear protection when operating this machine.
- Do not make any changes or modifications to this machine.
- This machine may start automatically or remotely at any time.
- Never stand or climb on the conveyor - use only an OSHA approved stepladder.
- Machine design including controls and logic should not be changed or modified since it may result in injury or damage to the conveyor.
- Do not operate the conveyor if the power cord is cracked or broken.



- If the conveyor shows signs of malfunction, turn off the electric power and unplug the power cord.
- Do not operate the conveyor if there is obvious damage to the conveyor.
- Dry location use only. Do not expose the conveyor to rain, water, wet, or damp conditions or locations.
- Do not abuse the power cord. Never pull on the cord to disconnect from the electrical outlet. Keep cord away from heat, oil, and sharp edges.
- Be sure the power switch is in “off” position when plugging in the conveyor.
- If fluid splashes on the conveyor, unplug the conveyor immediately. Wipe the conveyor with an absorbent cloth to prevent damage. The conveyor must remain unplugged until it has been thoroughly dried.
- A reminder to turn off the electric power and unplug the power cord before cleaning or servicing, or when the conveyor is not in use.
- Do not block the face panel of the speed control box. The power switch must always be easy to access. The power cord must always be easy to disconnect from the electrical outlet.
- When conveying hazardous chemicals and/or biological agents, take all suitable protective measures, such as wearing protective glasses and gloves resistant to the substances used. Follow local and/or national regulations for safe operation and maintenance of the system.
- Do not wear loose or baggy clothing when you operate the conveyor. Remove anything that may cause injury, i.e. neck ties, jewelry, etc. Tie back long hair.



**CAUTION:**

- This product is not intended for use in washdown environments.

## Lockout/Tagout Procedures:

The following guidelines are provided to establish a minimum requirement for the lockout of energy isolating devices whenever maintenance or service is performed on equipment and associated parts. It is further advised that an independent safety study be performed on the machinery, its installation, and the Lockout/Tagout procedures.

1. Follow the safety procedures specified in the safety section of this manual, as well as the safety procedures specified throughout this manual.
2. Stop the equipment using the normal procedure of pressing the stop button as explained on page 14 of this manual.
3. The equipment can be isolated from its electrical energy source by unplugging the main AC power cord from the electrical outlet and then enclosing the male plug of the AC power cord into an electrical plug cover (not included) as in the example shown in the picture to the right. Once the male end of the plug cover is enclosed, a padlock (not included) can be utilized to lock the male plug into the plug cover, preventing its use.



## Lifting Points on the Bottomless Conveyor

When lifting and carrying the bottomless conveyor, it is recommended that at least two people are involved. Before lifting, ensure that the AC power cord of the conveyor is unplugged, and the cord is organized in such a way as to not become damaged during the movement of the conveyor. Ensure all parts of the conveyor are tightly fastened to ensure that these parts will not move when the conveyor is lifted. Both carriers should stand on opposite ends of the conveyor, placing their hands under the corners of the deck, as shown in the image to the right.



## Specifications:

<b>Available Width</b>	<b>0" - 8"</b>
<b>Available Length</b>	<b>3 feet</b>
<b>Horse Power</b>	<b>3/8 HP</b>
<b>Speed</b>	<b>Up to 80 ft/min</b>
<b>Belt Material</b>	<b>Urethane Traction Belt</b>
<b>Floor to Belt Height</b>	<b>Adjustable from 35.5 – 42 inches</b>
<b>Electrical Requirements</b>	<b>115VAC ± 10%, 50/60 HZ, 5.7 Amp. Single Phase Electricity</b>

## Electrical Requirements

### Input Voltage and Current (from electrical outlet to the motor controller):

Input Voltage: 115 VAC ± 10%, 60 Hz. single phase.

Maximum Input Current (Continuous): 5.7 amps.

<b>Input Voltage &amp; Current</b>	<b>AC Voltage</b>	<b>Phase</b>	<b>Current</b>
<b>USA</b>	<b>115V</b>	<b>Single Phase Grounded</b>	<b>15A Service 5.7A</b>
<b>Canada</b>	<b>115V</b>	<b>Single Phase Grounded</b>	<b>15A Service 5.7A</b>

### Output Voltage and Current (from the motor controller to the motor):

Output Voltage (from control box to the motor): 0 – 130 VDC.

Maximum Output Current (continuous): 3.2 amps DC.

Maximum Output Current (peak): 5.0 amps DC.

## The Parts of the Bottomless Conveyor

The bottomless conveyor is shown below. The belts, cassettes, motors, motor control box, width adjustment handles, and height adjustable feet are indicated.

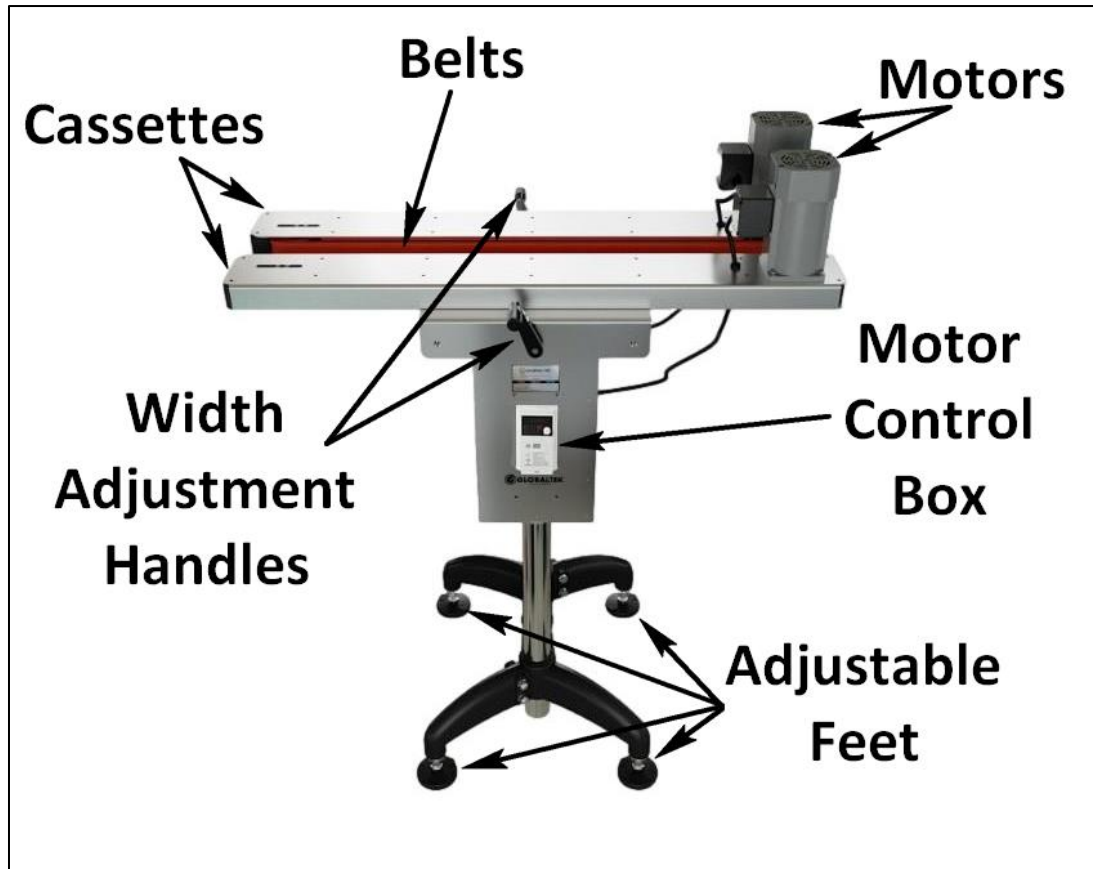

### The Motor Controller

The motor controller is located in a box mounted to the stainless-steel frame above the legs of the conveyor.

The motor controller is manufactured by Brother. It is their Model GF15N020-BMRG2C, the Mini Series In-Line Gear Motor Type G. For more information, including a downloadable data sheet, as well as downloadable schematics and drawings, you can visit the following link to their web site:

<https://datasheets.globalspec.com/ds/brother-industries/gf15n020-bmrg2c/4294903f-ae03-4071-9eb1-73468cb11554>

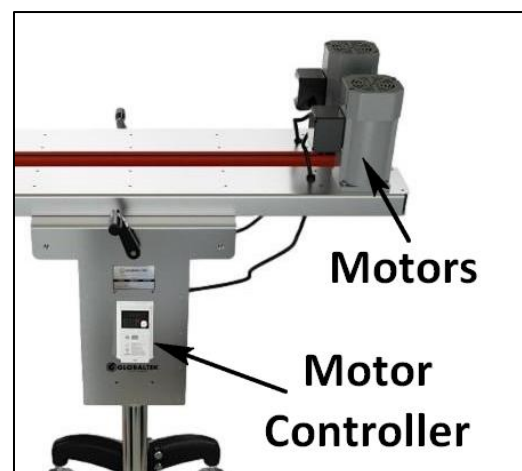

A close up view of the motor controller is shown below, the current speed indicator, speed control, start button, and stop button are indicated. The four buttons featured in the white box below come standard with the control box, but you are unlikely to need to use them.



### The Start and Stop Buttons

The start and stop buttons are located at the bottom left corner of the control box and are shown in the image below.



- To turn the bottomless conveyor on, press the green “RUN” button.
- To turn the bottomless conveyor off, press the red “STOP” button.

The conveyor will automatically revert to “STOP” when it is introduced to or removed from its power source. Still, it is a good practice to set the conveyor to “STOP” before doing this.



**NOTE:** It is recommended to set the conveyor to “STOP” before introducing or removing the conveyor’s power source.

## The Speed Control

The speed control dial is located on the right side of the controller and is shown in the picture to the right.

The speed control dial can be turned to change the speed of the conveyor. Turning the speed control dial clockwise increases the speed. Turning the speed control dial counterclockwise decreases the speed.



## The Current Speed Indicator

The small screen featured in the picture to the right indicates the current speed of the conveyor in feet per minute.



## AC Power Cord

The bottomless conveyor is equipped with a 7-foot AC power cord that has a 3-prong plug with ground pin. The AC power cord is securely fastened to the bottom of the control box and cannot be removed.

The AC power cord will run out from beneath the conveyor shell as shown in the picture to the right.

## Connecting the Power Cord to an Electrical Outlet:

The power cord is the mains disconnect for the bottomless conveyor. The power cord must be connected to an electrical outlet that provides 115 VAC  $\pm$  10%, 50/60 Hz. single phase electricity. Make sure that the outlet is overload protected and of sufficient amperage capacity (5.7 amps). If there is any doubt that the outlet box complies with this specification, have a qualified electrician inspect the outlet box.

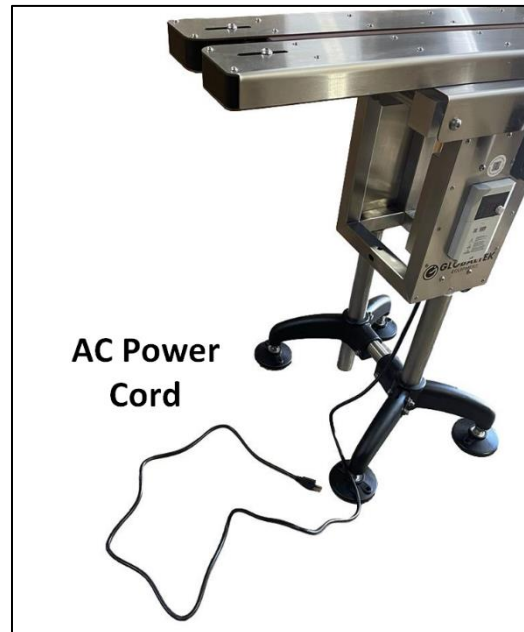



**CAUTION:**

The power cord must be connected to an electrical outlet that provides 115 VAC  $\pm$  10%, 50/60 Hz. single phase electricity. Make sure that the outlet is overload protected and of sufficient amperage capacity (5.7 amps). If there is any doubt that the outlet box complies with this specification, have a qualified electrician inspect the outlet box.

**Grounding Instructions**

The AC power cord must be plugged into a properly installed AC electrical outlet that is grounded in accordance with all codes and ordinances. Never modify the plug in any way. Check with a qualified electrician if you think the outlet may not be properly grounded.



**CAUTION:**

The AC power cord must be plugged into a properly installed AC electrical outlet that is grounded in accordance with all codes and ordinances. Never modify the plug in any way. Check with a qualified electrician if you think the outlet may not be properly grounded.

**The Motors**

The motors are located on top of the belt decks and designated in the picture to the right.

The motors are manufactured by Brother. It is their model GF15N020-BMRG2C, the Mini Series In-Line. For more information, including a downloadable wiring diagram, schematics, and drawings, you can visit the following link to their web site:

<https://productconfigurator.brother-usa.com/ProductConfigurator/Detail.aspx?ProductId=GF15N020-BMRG2C>.

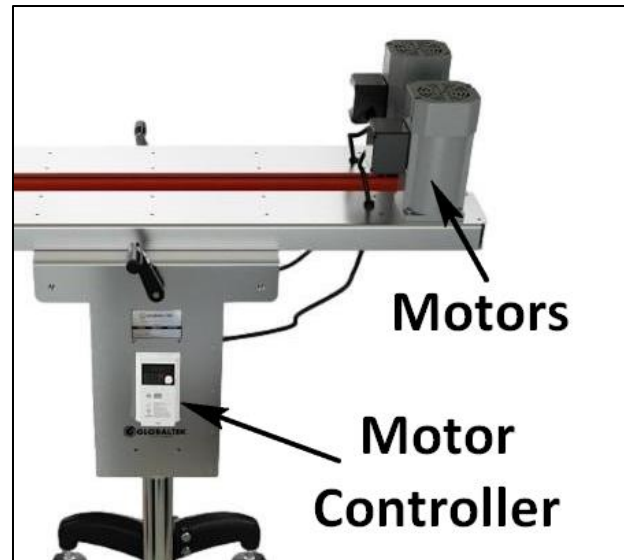

## Height Adjustable Feet

An adjustable foot is shown to the right. The height adjustment nut and foot jam nut are indicated.

The height adjustment nut locks the foot in place once the desired height of the conveyor is determined.

The foot jam nut is locked to the round foot. Rotating the foot jam nut rotates the foot. The foot jam nut provides an easy means of rotating the foot when raising, lowering, or leveling the conveyor.

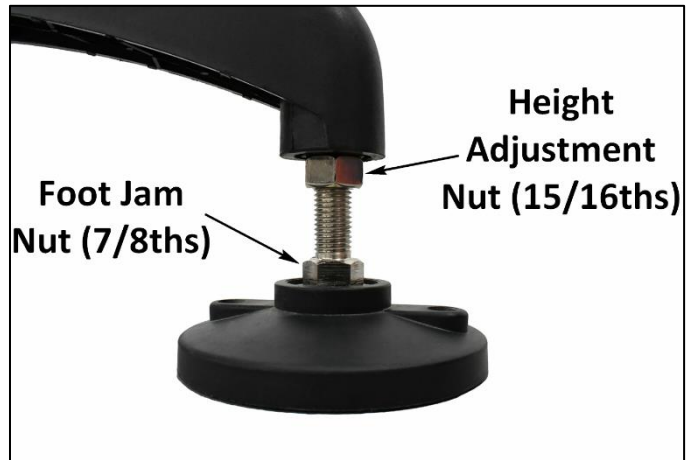

## Raising and Lowering the Bottomless Conveyor

To raise, lower, or level the conveyor, first loosen the height adjustment nut with a 15/16<sup>th</sup> wrench as is shown in the image to the right.

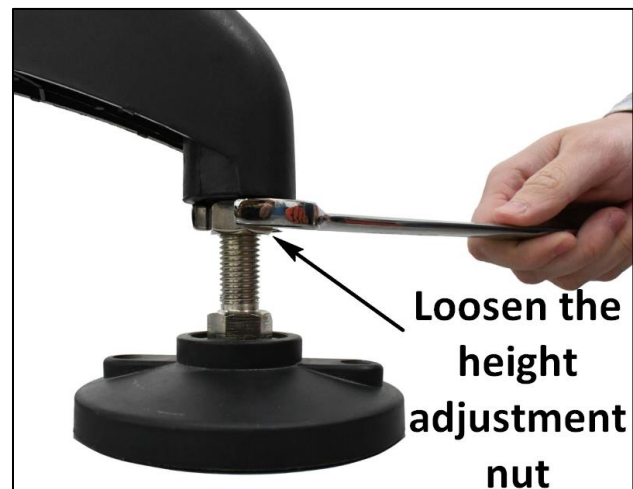

With the height adjustment nut loose, rotate the foot jam nut with a 7/8<sup>th</sup> wrench. To raise the conveyor, rotate the foot jam nut clockwise. To lower the conveyor, rotate the foot jam nut counterclockwise.

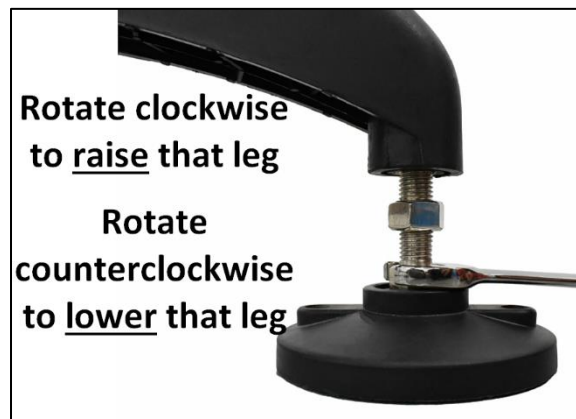



When the conveyor is at the desired height, tighten the height adjustment nut against the leg of the conveyor with a 15/16<sup>th</sup> wrench.

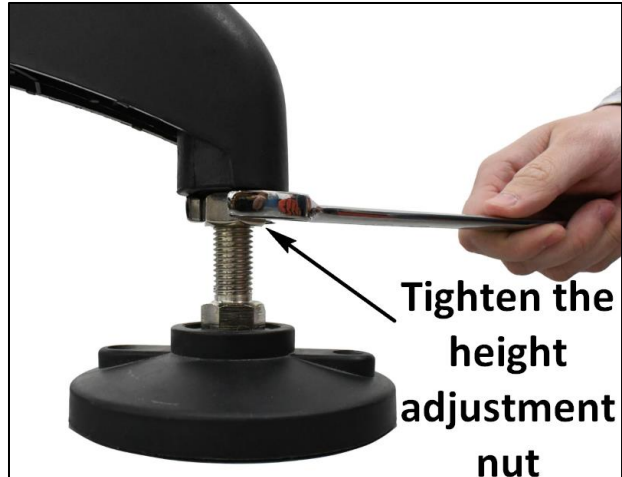

### Leveling the Conveyor

To level the conveyor, place a level along one of the conveyor belt decks as shown in the picture to the right.



If adjustments are required, loosen the height adjustment nuts on the feet of the conveyor with a 15/16<sup>th</sup> wrench.

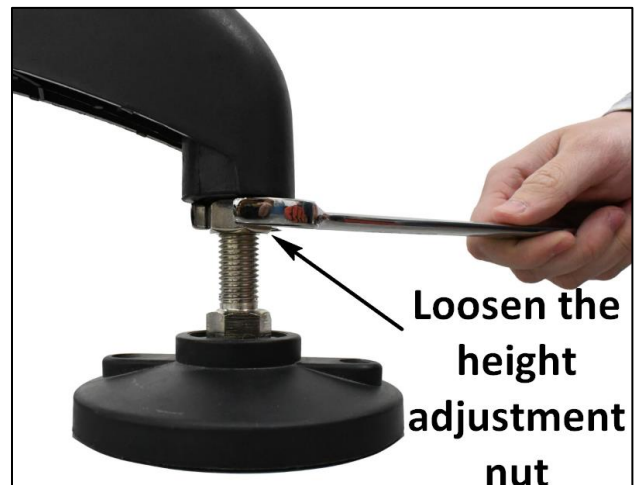

With the height adjustment nut loose, rotate the foot jam nut with a 7/8<sup>th</sup> wrench. To raise the conveyor, rotate the foot jam nut clockwise. To lower the conveyor, rotate the foot jam nut counterclockwise.

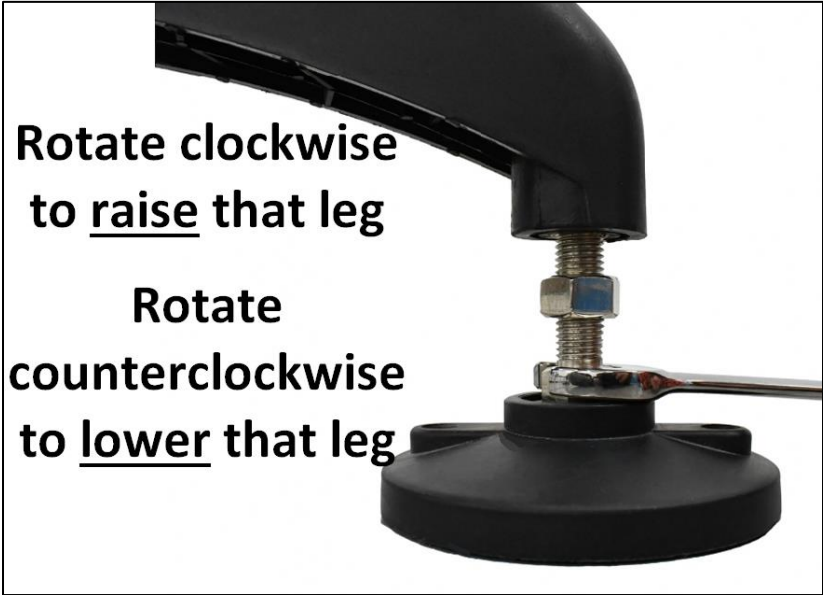

When the conveyor is level, tighten the height adjustment nut against the leg of the conveyor with a 15/16<sup>th</sup> wrench.



## The Belts

The belts on the standard bottomless conveyor are high-friction urethane belts. They are designed to grip containers from the side while transporting them through your packaging line.

### Adjusting the Width of the Belts

Depending on the size of your container, the width of the bottomless conveyor belts will likely need to be adjusted. Follow these instructions to do so.



1. Both sides of the bottomless conveyor feature a belt width adjustment handle, as shown in the picture above and to the right. Turning a handle will move the belt cassette located above it inwards or outwards.
2. Turning a width adjustment handle clockwise will move the corresponding cassette inwards towards the other cassette, making the track smaller. Turning the width adjustment handle counterclockwise will move the same cassette outwards, widening the track.



3. Use one of your containers to make the necessary adjustments to your belt width. Widen the belts so that the container fits between them, then shrink the gap once more so that the belts lightly squeeze but do not deform, your container. When you let go of the container, the belts should hold it in place.



## Adjusting the Height of the Belts

The height of the belt cassettes can be changed so that your bottomless conveyor can better fit into your packaging line.

1. The height of the conveyor can be slightly changed by adjusting the height of the adjustable feet following the instructions found on page blank of this manual.
2. The leg assembly, shown in the picture to the right, can also be used to adjust the height of the conveyor.

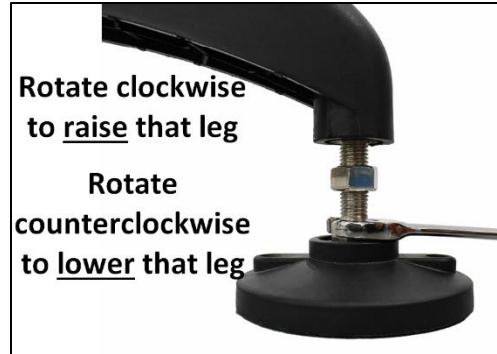

The black plastic casing around each conveyor column clamps around the column to hold it up. Loosening the screws in the casing, designated in the picture to the right, will loosen the clamp around the conveyor column and allow it to move up and down. Ensure that a partner is standing by to support the conveyor in case it quickly falls.

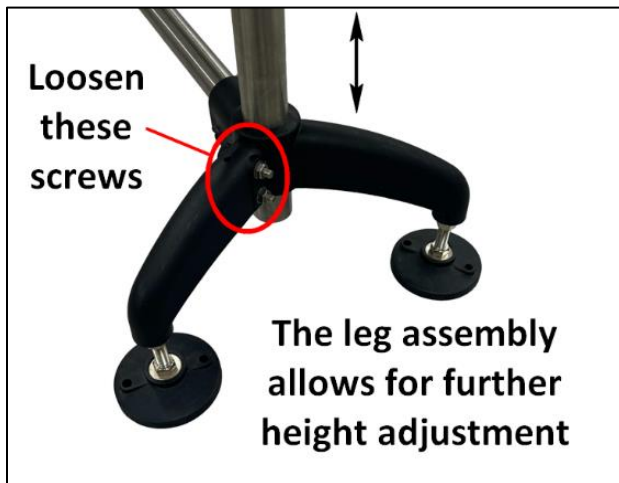

3. When the both leg assemblies have been loosened, two operators can lift and adjust the height of the conveyor.



4. Position the bottomless conveyor cassettes so that they rest at the approximate center of a container sitting on your inline conveyor. When satisfied with the height of your bottomless, retighten the screws in the bottomless conveyor leg assemblies to lock the height in place.



## Adjusting the Tension of the Belts

For optimal performance of the bottomless conveyor, it is recommended to occasionally check on and adjust the tension of your belts. If you find that containers are either not fitting into or falling out of the conveyor track, you may need to adjust the tension of your belts.

1. First use 7/32-inch hex key to loosen, but do not remove, the bolt in the sprocket at the end of the belt cassette, as designated in the picture to the right.



2. With the sprocket loosened, insert a sturdy flathead screwdriver or similar tool between the Delrin strip on the inside of the cassette and the sprocket. A picture of this can be seen to the right. The belt should grow visibly more taut.

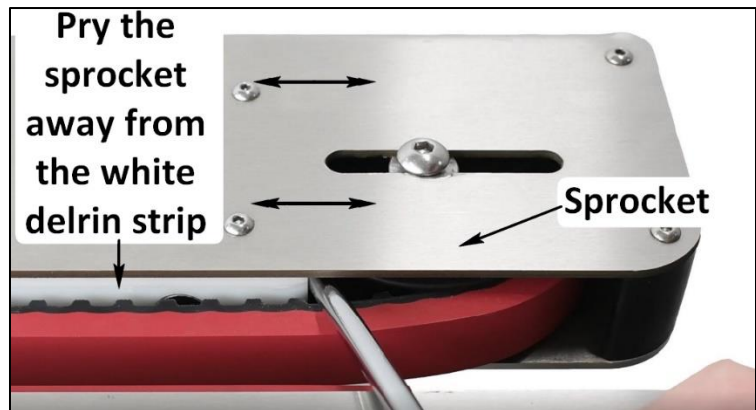

3. Gently, but firmly, pry with the screwdriver so that the sprocket is pushed away from the Delrin strip in the cassette, as shown in the image to the below. In this image we have removed the top plate to show a better view of what is going on inside the cassette, but you should not do this when increasing the tension.

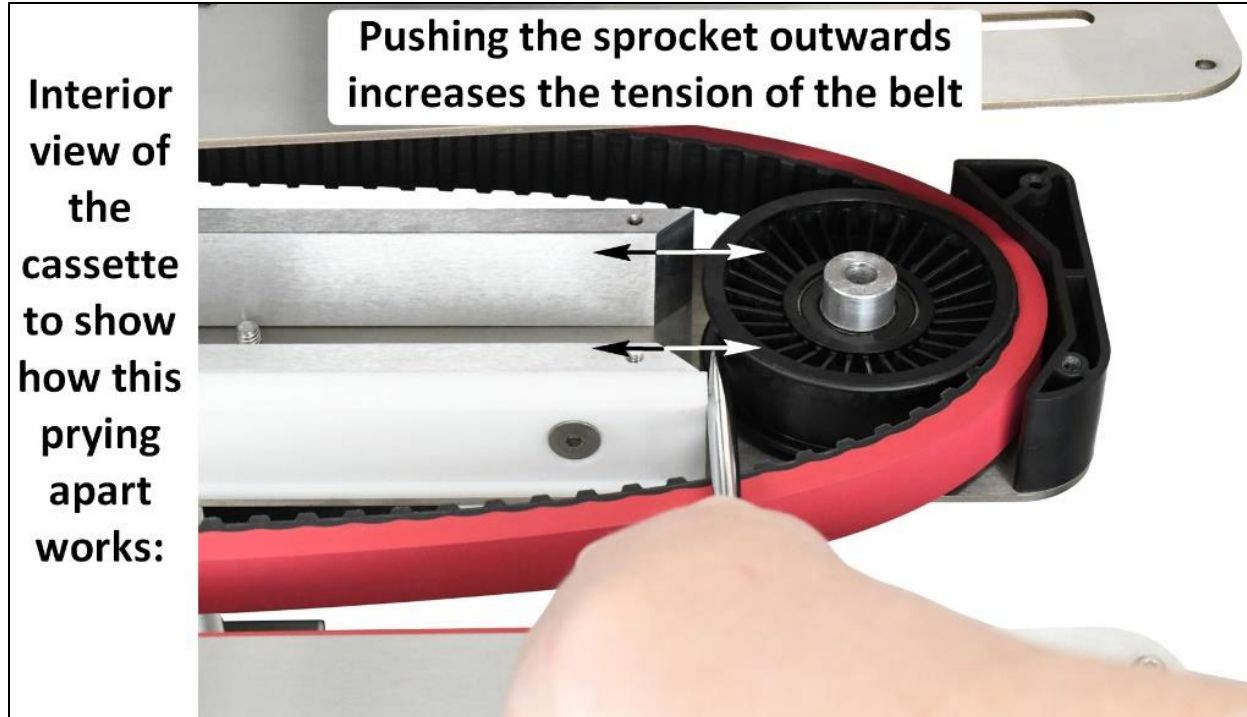

4. Hold the sprocket in place tightly while a partner retightens the sprocket bolt and nut using a 9/16" wrench and 7/32" key.



## Replacing the Belts

After long-term use, the belts on your bottomless conveyor may wear and need to be replaced. When this occurs, it is a simple procedure to replace the belt using the instructions below.

1. Remove the sprocket bolt using a 7/32" hex key and 9/16" wrench, as shown in the picture to the right. Set the sprocket, washer, and bolt aside for now.

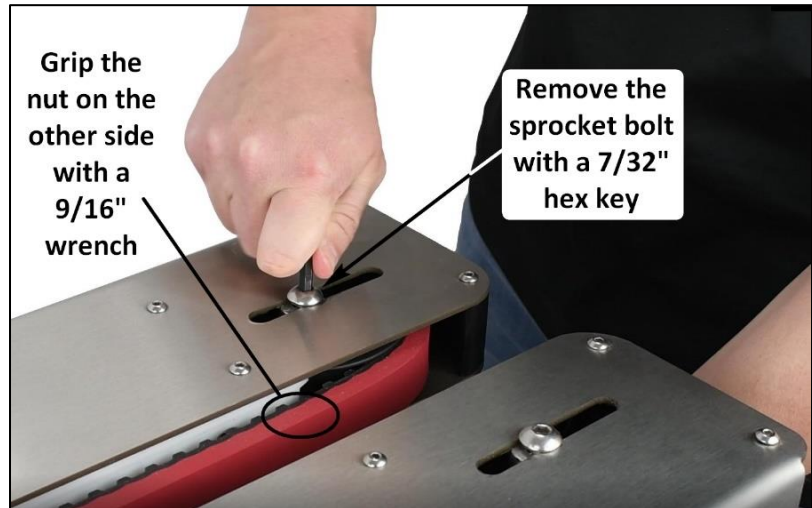

2. Remove the 14 screws fastening the top plate of the cassette to the body using a 1/8" hex key, as shown in the picture below.

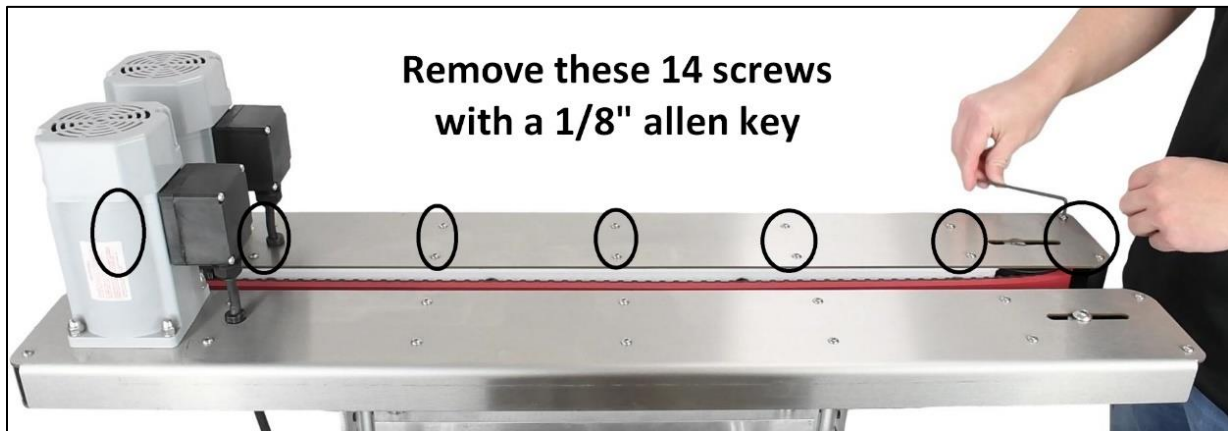



3. With the sprocket bolt and screws removed, the top plate of the belt cassette can be lifted off of the cassette. It cannot be completely removed, so it is recommended that another operator comes and holds the plate a few inches above the cassette while the first works inside the cassette, as shown in the picture below.

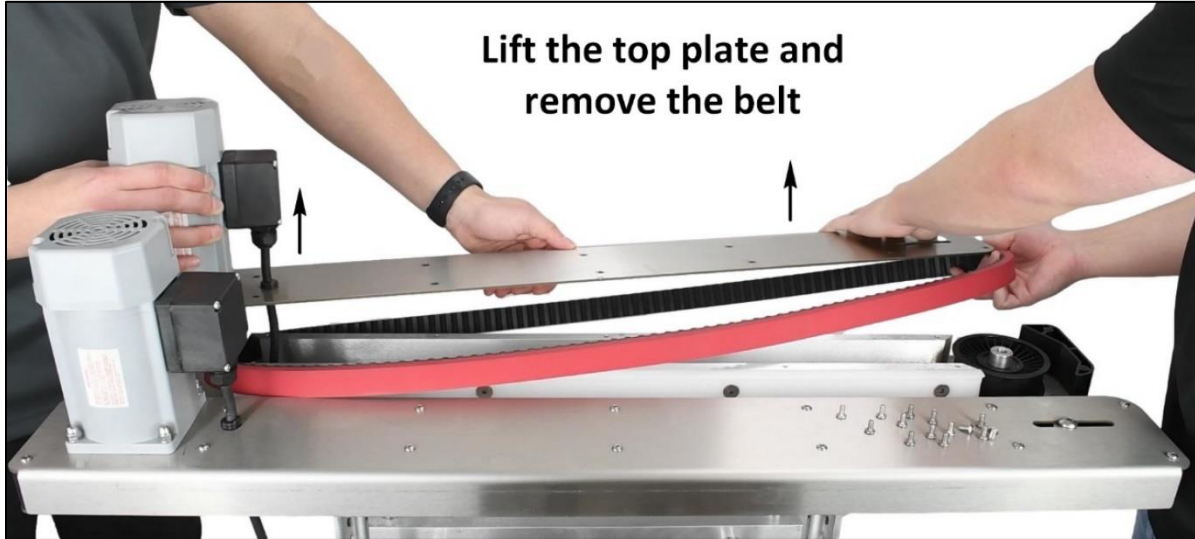

4. The operator with their hands free should carefully remove belt from around the two sprockets in the cassette, pulling the belt up and over the top plate of the cassette and off of the machine, as shown in the picture below.

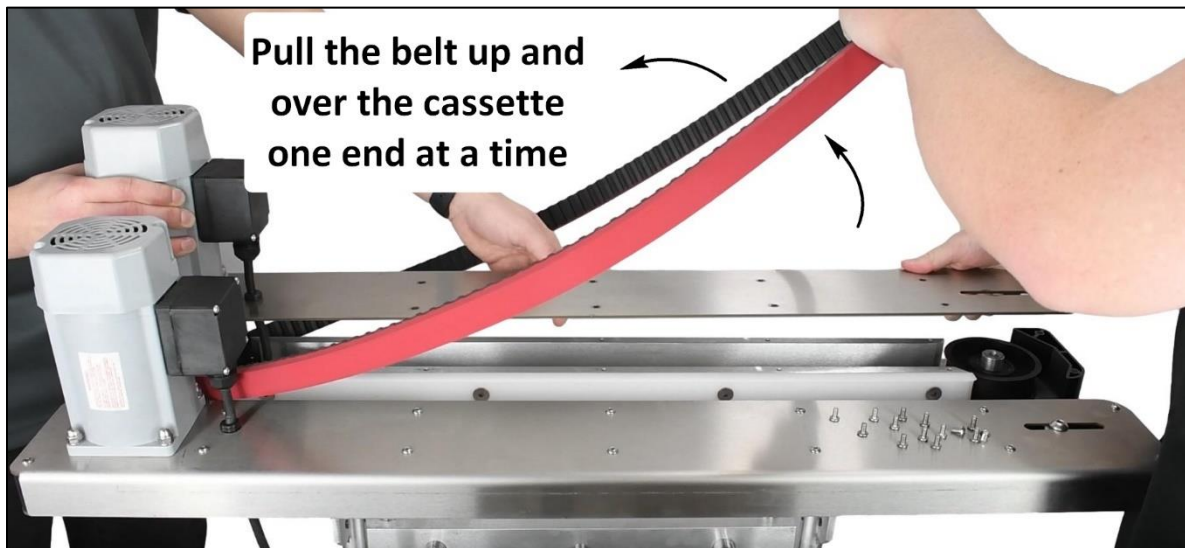

5. Have one operator continue to hold the top plate up while the other begins placing the fresh belt over it. It can be placed in the same manner the old one was taken off, by slowly but surely working it over the plate from the top down.



6. Once the belt is back underneath the metal of the top plate, ensure that it is properly wrapped around the sprockets in either end of the belt cassette.



7. Push the top plate back onto the body of the cassette, ensuring that the belt is packed away nicely inside. Have one operator line up the holes in the top plate and hold the plate in place while the other begins reinserting the hardware, starting with the sprocket bolt.

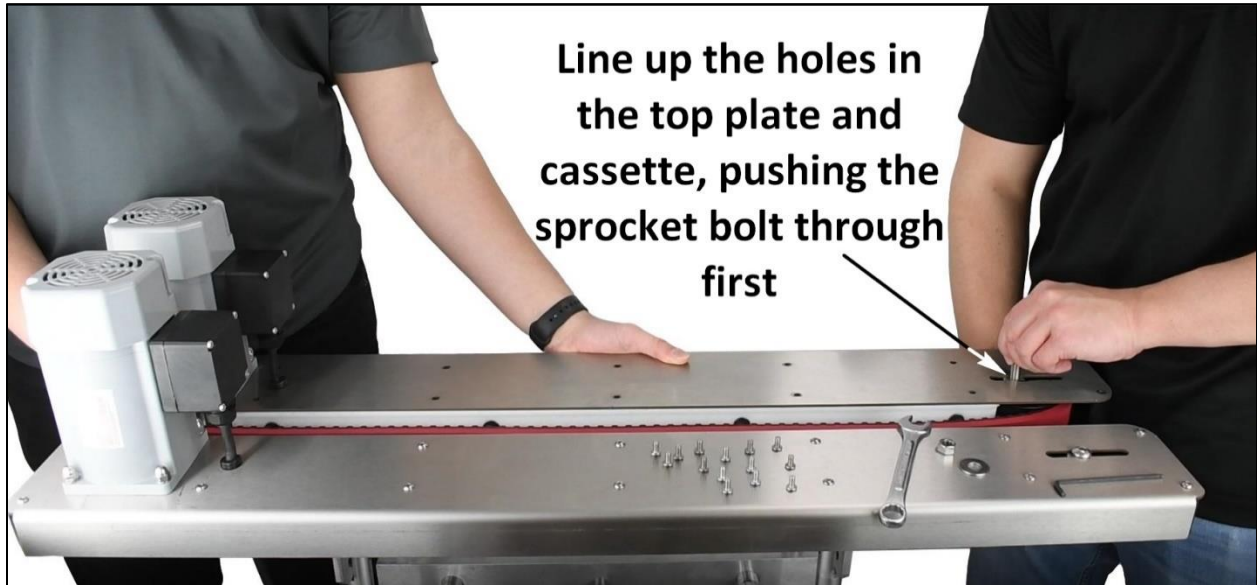

8. Tighten the sprocket bolt, washer, and nut so that the sprocket is held firmly in place. Continue on to reinsert and tighten the other 14 screws in the cassette assembly, as shown in the picture below and to the right. Your cassette is now fully reassembled.



9. Adjust the tension of your new belt using the instructions found on page 24. With your belt replaced, you are now ready to resume use of your bottomless conveyor.

## Unpacking the Bottomless Conveyor

1. The tools shown in the image to the right are required to unpack and assemble the bottomless conveyor. Any tool suitable for cutting plastic can be used in place of the shears.



2. The T25 torx bit is included within the packing slip at the top of the crate. Open the packing slip to remove the T25 torx bit. The packing slip with enclosed T25 torx bit is shown in the image to the right.



3. The conveyor will arrive in a box as shown in the picture to the right. Use the T25 Torx bit with any standard screwdriver to remove the screws and washers around the bottom perimeter of the cardboard box.



4. The pallet and bottomless conveyor when the box has been removed are shown in the picture to the right. The conveyor is fastened to the pallet with a set of straps over the frame of the machine and a screw in each of the conveyor's four feet.

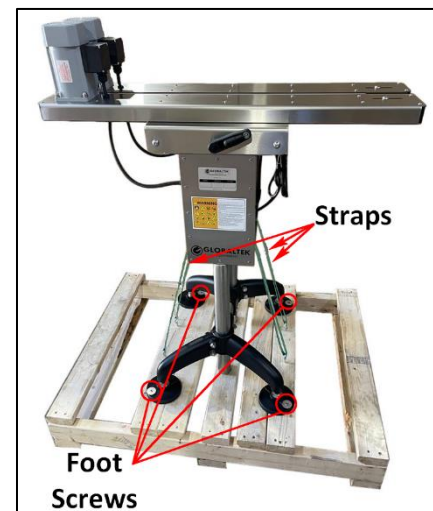

5. Use your screwdriver and T25 torx bit to remove the screw and washer in each of the four feet of the conveyor, as shown in the picture to the right.



6. Use a pair of shears to cut the straps holding the conveyor in place, as shown in the picture to the right.



7. Enlist a partner to help lift the bottomless conveyor off of the pallet. Lift at the lifting points mentioned on page 11. The pallet can now be disposed of.

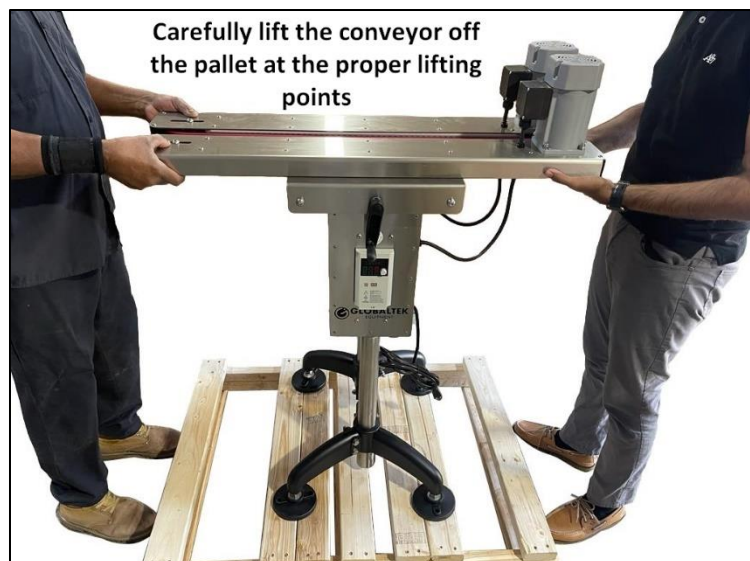

## Operating Instructions (Getting Started):

1. Unpack the bottomless conveyor following the instructions found on pages 29 of this manual.

2. Choose the container you wish to carry with the conveyor. Adjust the width and angle of the belts to fit the object following the instructions found on page 20 of this manual.

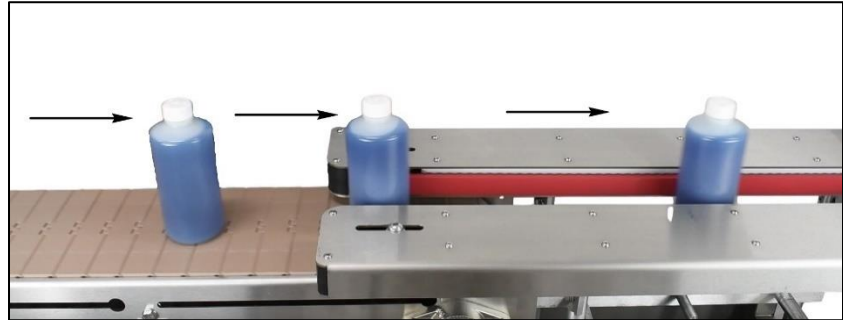

3. Adjust the height of the cassettes following the instructions found on page 15 of this manual.

4. Before plugging the AC power cord into an electrical outlet, press the “STOP” button on the motor controller, just in case. For more information on the controller, and turning the conveyor on and off, please see pages 14 of this manual.



5. Plug the AC power cord into an electrical outlet that provides 115 VAC  $\pm$  10%, 50/60 Hz. single phase electricity. Make sure that the outlet is overload protected, grounded, and of sufficient amperage capacity (5.7 amps). If there is any doubt that the outlet box complies with this specification, have a qualified electrician inspect the outlet box.

For more information on the AC power cord, see page 15 of this manual. For more information on the electrical requirements of the conveyor, see page 12 of this manual.



### CAUTION:

Plug the AC power cord into an electrical outlet that provides 115 VAC  $\pm$  10%, 50/60 Hz. single phase electricity. Make sure that the outlet is overload protected, grounded, and of sufficient amperage capacity (5.7 amps). If there is any doubt that the outlet box complies with this specification, have a qualified electrician inspect the outlet box.

6. The conveyor is now ready for use. Press the “RUN” button on the motor controller. For more information of the controller, and turning the conveyor on and off, please see pages 14 of this manual.
7. Adjust the speed of the conveyor by rotating the speed control dial. The speed control dial is located on the right side of the control box and is shown in the picture to the right. For more information on speed control, see page 15 of this manual.



# Installing a Printer on your Bottomless Conveyor:

Bottomless conveyors allow access to nearly all surfaces on a container, and thus are perfect for use in tandem with printing or labeling machines. If you have purchased an inkjet printer from us, this guide will demonstrate the proper way to install it.

## Components of the Inkjet Printer

The inkjet printer is shown below. It is comprised of a printer, sensor, and console. These three primary components are all attached to the conveyor using the printer clamp, printer rod mounts, and printer rods. This system is highly adjustable and allow the user to adjust the exact printer setup as they see fit.

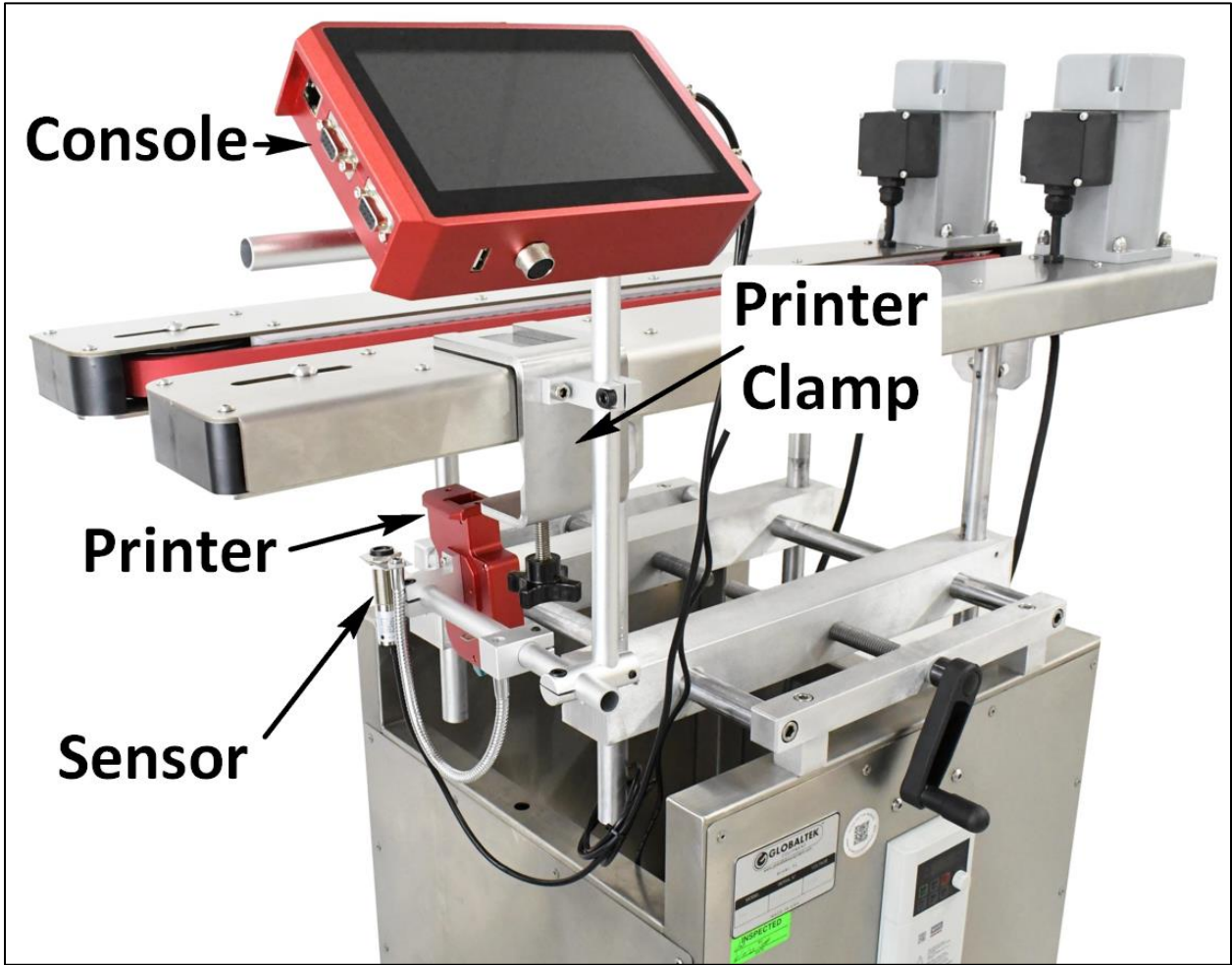



## Mounting the Printer

1. The printer clamp is an extra piece that prevents scratching and makes mounting your printer to your conveyor far easier. The printer clamp is shown in the picture to the right.

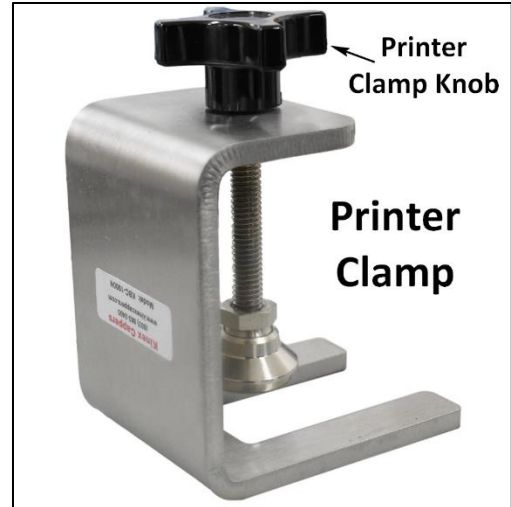

2. The printer rod mounts are shown in the picture below and to the left. Each printer rod mount has two screw holes in its base, but one mount has larger holes than the other two. This is the mount you should attach to the two holes in your printer clamp using the 5mm hex key and screws that came with your printer.

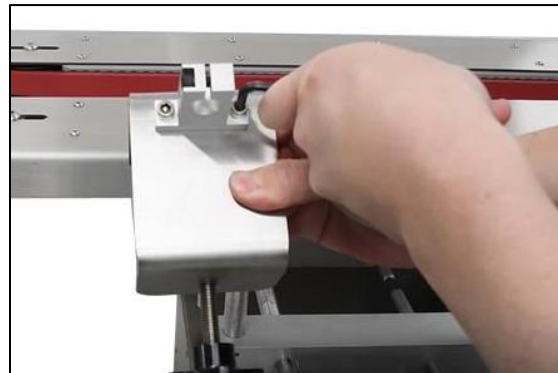
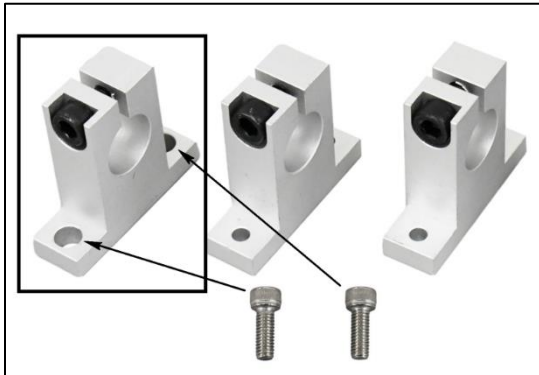

3. Apply the larger piece of anti-rotation material to the underside of the prongs on the clamp, as shown in the image to right. The smaller piece should be attached to the inner end of the printer clamp knob. This padding will prevent the clamp from scratching the stainless-steel finish on your bottomless conveyor.



4. Fasten the printer clamp at the spot you would like for your printing to take place. We recommend mounting the clamp at the opposite end of the conveyor from the motors.

Tighten the printer clamp knob to lock it in place.

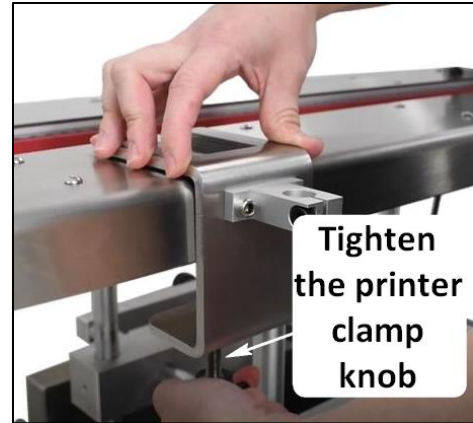

5. Thread one of the three printer mounting rods, shown in the picture below, through the printer mount on the clamp. Thread it down far enough so its end protrudes past the clamp knob. Tighten the set screw in the printer mount on the clamp using the 5mm hex key to lock the rod in place.

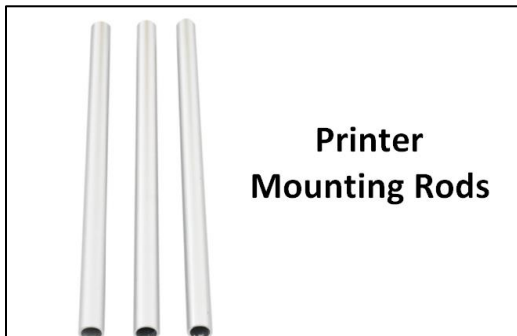

6. The printer mounting joints are shown in the picture to the right. They should be attached to either end of the rod you just mounted using the 5mm hex key to fasten them in place. The top joint should be mounted so it is perpendicular to the flow of the conveyor. The bottom joint should be mounted parallel.

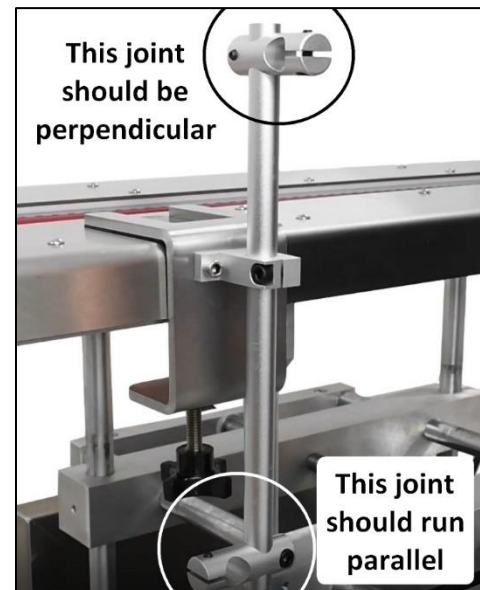

7. Thread and fasten a printer mounting rod through the top joint. This is the rod we will be mounting our console to, so ensure that it is mounted somewhere comfortable for the operator.

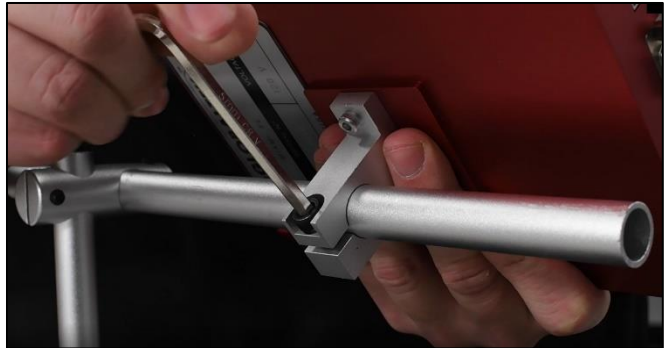
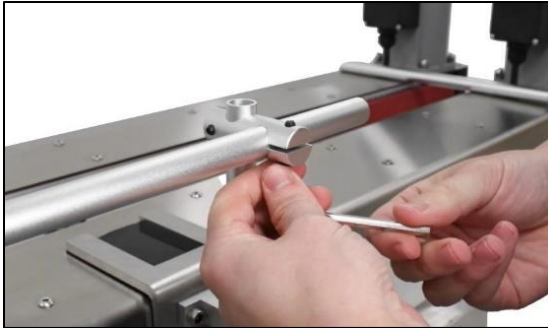

Mount the console on the newly attached rod as in the image above and to the right, using the 5mm hex key to fasten the printer mount to the rod.

8. Thread and fasten a printer mounting rod through the bottom joint. This is the rod we will be mounting our sensor and printer to.



9. Place a container between the conveyor belts at the point where you want printing to take place. We will be using this bottle as a reference as we set up our sensor and printer.



10. Your sensor is attached to its mounting bracket by a goose neck arm. Thread the sensor mounting bracket onto the lower mounting rod, as shown in the picture to the right.

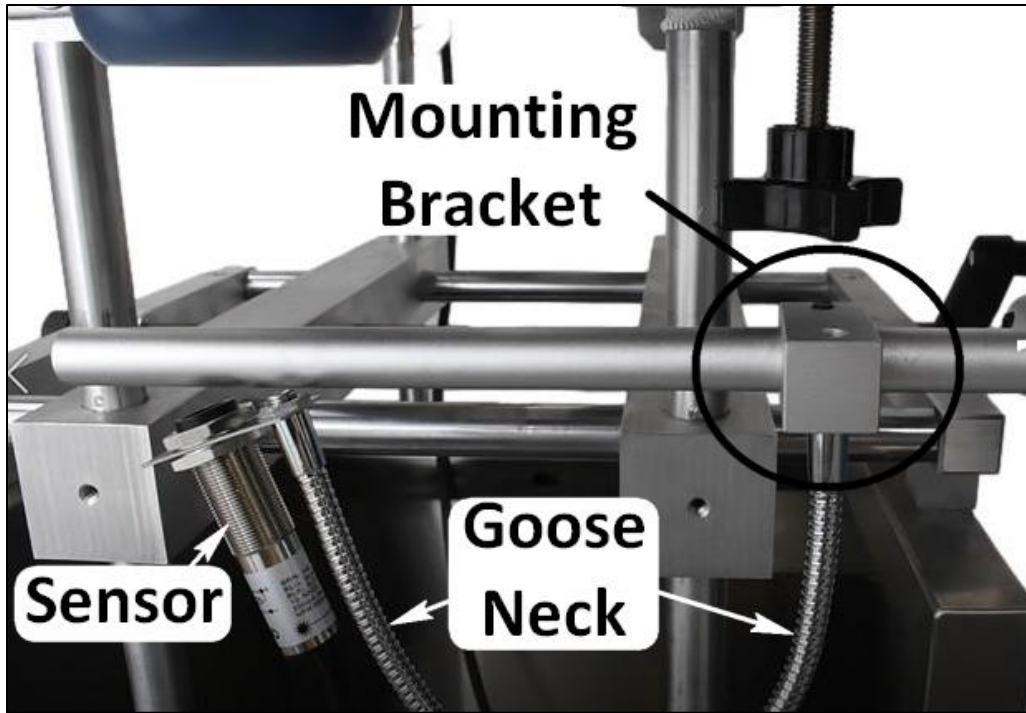

Your sensor and goose neck will eventually need to be positioned so they are pointing directly at the bottle. Set the mounting bracket at the point on the bar where this positioning will be easiest, then tighten the mounting bracket with a 5mm hex key.

11. Mount the printer on the same rod. Center it under the bottle you placed in your conveyor before locking it in place using the 5mm hex key.

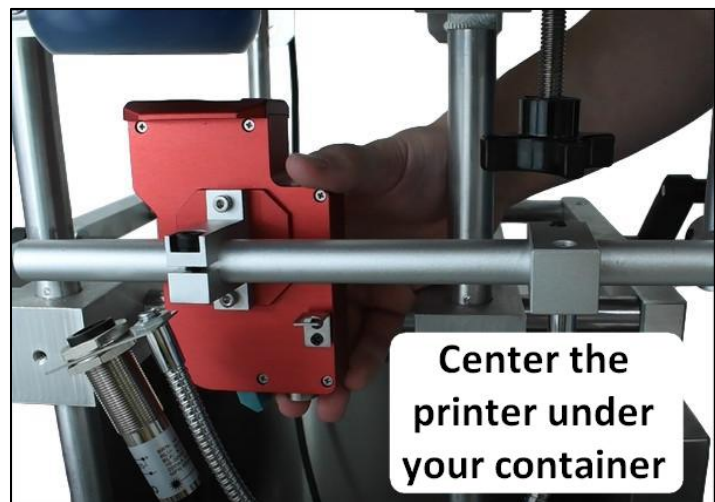

12. Position the sensor so it is slightly upstream of the printer and pointing directly at the container in the conveyor.

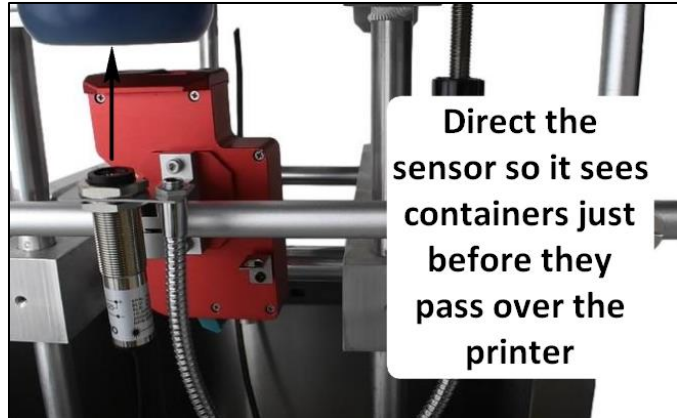

13. Plug the sensor cord into the top port on the right side of the console by tightening the threaded barrel connector over the port.



14. Introduce power to the printer by plugging the printer power cord into the bottom port on the right side of the printer.



15. Plug the power cord into a properly grounded electrical outlet. Your printer should now be ready for use.



This is just one possible setup for the inkjet printer, where it is set up to label the bottom of standard bottles. However, the rod mounting system is highly adjustable and can accommodate many different containers and printing locations. Do not hesitate to modify your setup based on your needs.

## Troubleshooting:

<b>PROBLEM</b>	<b>POSSIBLE CAUSE</b>	<b>REMEDY</b>
Motor won't run	<ol style="list-style-type: none"> <li>1. Power off</li> <li>2. Limit switch activated</li> <li>3. Blown fuse</li> </ol>	<ol style="list-style-type: none"> <li>1. Restore power</li> <li>2. Remove object &amp; adjacent linkage</li> <li>3. Replace fuse</li> </ol>
Motor runs; Belt does not	<ol style="list-style-type: none"> <li>1. Set screw on drive pulley loose</li> <li>2. Gear box oil</li> <li>3. Set screws thru bearing to drive shaft loose</li> </ol>	<ol style="list-style-type: none"> <li>1. Tighten screw</li> <li>2. Check oil &amp; refill if required - Repair leak &amp; inspect gears</li> <li>3. Tighten set screws</li> </ol>
Motor runs intermittently	<ol style="list-style-type: none"> <li>1. Loose wire connection</li> </ol>	<ol style="list-style-type: none"> <li>1. Check wires</li> </ol>
Belts do not run smoothly	<ol style="list-style-type: none"> <li>1. Excessive slack</li> <li>2. Drive chain has excessive slack</li> <li>3. Object under belt</li> </ol>	<ol style="list-style-type: none"> <li>1. Remove slack by adjusting</li> <li>2. Remove slack</li> <li>3. Remove object</li> </ol>
Belt squeals while running	<ol style="list-style-type: none"> <li>1. Slider pan surface dirty</li> </ol>	<ol style="list-style-type: none"> <li>1. Clean with shela shine polish</li> </ol>
Belt does not move	<ol style="list-style-type: none"> <li>1. Speed control knob loose</li> </ol>	<ol style="list-style-type: none"> <li>1. Tighten knob</li> </ol>

## Maintenance Guidelines:

Keeping the conveyor clean, and clear of accumulated debris, is essential to maintain proper operation of the conveyor.

### Cleaning Instructions

- Clean stainless steel surfaces with a soft cloth and a mild detergent intended for use with stainless steel.
- Flush with clean water or wipe down with a clean wet cloth, and then wipe dry to avoid streaking and spotting.
- Chlorinated detergents and sanitizing agents will damage stainless steel unless thoroughly flushed or wiped away.

Strong solutions used during the washing or cleaning process should be checked before use to determine their pH levels. Any pH value below 4.5 or above 9.0 will damage the stainless steel and plastic parts of the conveyor. If it is necessary to use a strong solution to clean the conveyor or any of its components, all residues of the cleaning agent should be thoroughly removed by flushing or wiping down with a soft cloth.

To avoid risk of electric shock or fire, or damage to the conveyor, never spray the motor, speed control or any of the electrical connections on the conveyor with water or any other liquid.



#### **WARNING:**

To avoid risk of electric shock or fire, or damage to the conveyor, never spray the motor, speed control or any of the electrical connections on the conveyor with water or any other liquid.

Do not spray water onto the flange bearing as this may cause damage to the conveyor.



#### **CAUTION:**

Do not spray water onto the flange bearing as this may cause damage to the conveyor.



#### **CAUTION:**

This product is not intended for use in washdown environments.



## Contact Technical Support:

Globaltek® Equipment  
Attn: Repair Dept.  
7354 NW 35th Street  
Miami, FL 33122  
USA  
**Telephone:** (305) 418-9632 / (305) 418-9633

## Warranty:

Globaltek® Equipment Inc., dba GlobalTek®, warrants all new machines against defects in material and workmanship from the manufacturer for a period of one (1) year from the date of purchase stated on the invoice.

The company will replace at no cost F.O.B. Miami, Florida, any part proving defective in materials or workmanship. Consumables and wear and tear items such as, but not limited to: Belts, Chains, Bearing, Wheels, Heating Elements, Mechanical Switches, Sealing Belts, Seals, Load cells, Blades, Fuses, etc., are not covered under warranty.

Defectiveness shall be verified by Globaltek® Equipment inspection and at the sole discretion of Globaltek® Equipment. Removal and installation expense shall be the responsibility of the purchaser. Globaltek® Equipment is liable solely for the furnishing of the defective part(s).

Globaltek® Equipment is not liable for consequential damages, such as loss of profit, delays or expenses incurred by failure of said part(s). Failure due to abuse, improper handling, installation, adjustments, operation and/or maintenance, as well as exposure to vibration, and/or exposure to the elements (including dust, sunlight, corrosion, high humidity conditions and temperature extremes) does not constitute failure due to materials or workmanship.

Globaltek® Equipment is not liable or responsible for repair, service, or installation charges, fees, or damages for correcting any defects.

During the applicable limited product warranty period, if a covered product is proven to be defective in workmanship or materials, Globaltek® Equipment will, at its option:

- (1) replace or repair the defective component; or
- (2) replace the product with a comparable product.